

B-Compact

OPERATING MANUAL



700.470.019 (Digital manual - English)

Model-no: • MB-001

All rights reserved.

No part of this document may be copied and/or published by means of printing, photocopying, microfilming or by any other means whatsoever without the prior written consent of the manufacturer. This also applies to the included drawings and/or diagrams.

The information in this document is based on data that was available at the time the design, the material characteristics and the operating methods were published, meaning that this document is subject to change.

The original instructions for this manual have been written in English. Other language versions of this manual are a translation of the original instructions.

For this reason, the instructions are merely a guideline for the installation, maintenance and repair of the B-Compact displayed on the front cover.

This document applies to the standard version of this B-Compact.

The manufacturer therefore declines all liability for any damage arising from specifications that deviate from the standard version of the B-Compact delivered to you.

This document has been compiled with the utmost care. However, the manufacturer cannot be held liable for any errors it contains or the consequences thereof.

Table of contents

1. General information	1
1.1 Manual languages	1
2.2 Warning	1
2. Parts and controls	1
2.1 Parts	1
2.3 Controls	2
3. Installation and prepare for use	3
3.1 Installation	3
3.2 Start up	4
3.3 Stop button	5
3.4 Standby	6
3.5 Prepare for use	7
3.5.1 Fill the coffee cone	7
4. Cleaning	8
4.1 Daily cleaning	8
4.2 Weekly cleaning	10
4.3 Periodic cleaning	12
4.3.1 Clean the gauge glass	12
5. Functions of the buttons	13
5.1 Automatic brewing	13
5.2 Only filling the machine	15
5.3 Fill and (pre-)heat	16
5.4 Daily rinse	18
5.5 Setting items	20
6. Special functions	23
6.1 Lid warning	23
6.2 Back to default settings	23
6.3 Lock mode (Buffet setting)	24
7. Errors	25
8. Storing the B-Compact	26

1. General information

1.1 Manual languages

This digital manual may be subject to change.

You can access the latest versions in different languages using the QR code below.



2.2 Warning

- ▶ *While filled, loose containers may not be moved by the handles. Handles have been provided to facilitate the handling of empty containers.*

2. Parts and controls

2.1 Parts

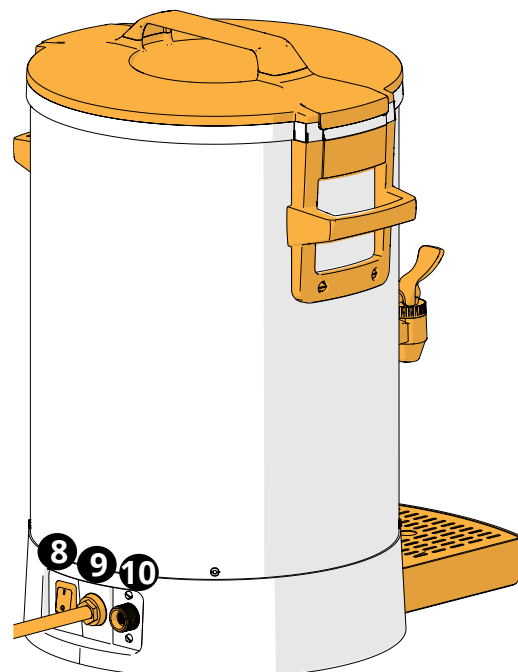
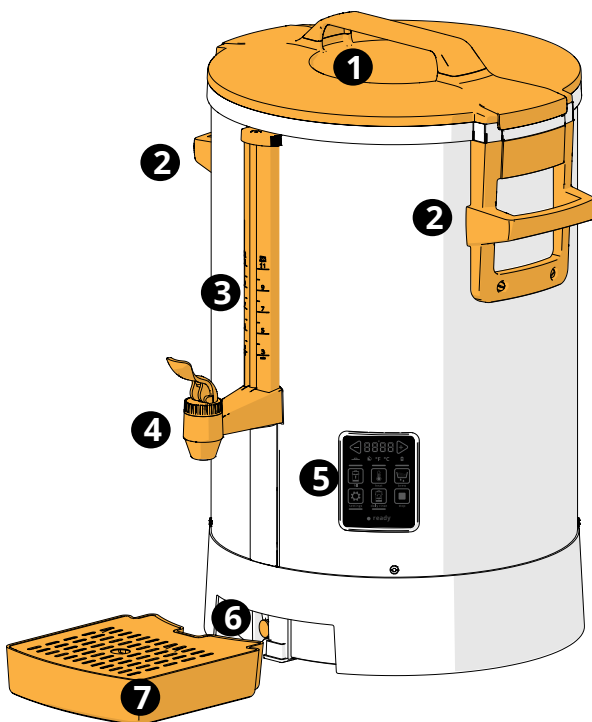

1. lid
2. handle
3. gauge glass
4. tap
5. user interface
6. drain hose
7. drip tray
8. on/off switch
9. electrical connection
10. water connection





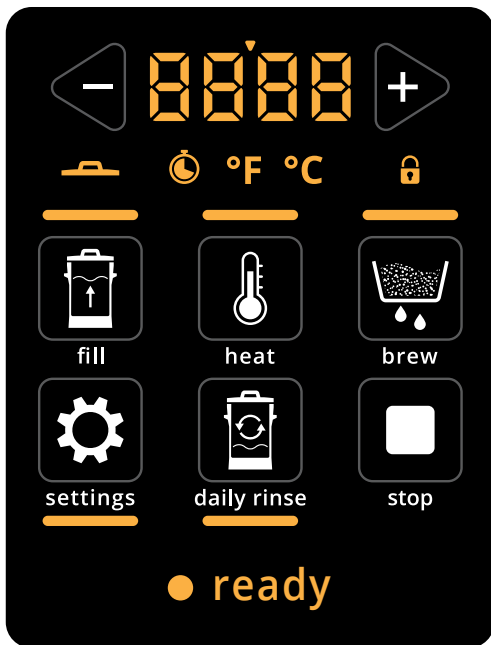



2.3 Controls

The basic buttons are described underneath.



basic buttons	function
	adjust value
	fill
	heat
	brew
	settings
	daily rinse
	stop

Indicators	function
	feedback value with number separator
	place lid
	time
	temperature unit
	lock
	B-compact is standby
	ready to dispense

3. Installation and prepare for use

3.1 Installation

Requirements:

- min. water pressure (supply) : min. 250 kPa (2,5 bar)
: max. 1000 kPa (10 bar)
- flow rate : ±10 l/min
- electrical values : see the identification plate



700.403.347 (STD) |
700.403.769 (AR FA) |
700.403.839 (ZH/KO/JA)

3.1a

1. read the safety booklet

- ▶ *Before putting the appliance into operation, clean the inside of the kettle, see [§4.2 Weekly cleaning on p.10.](#)*

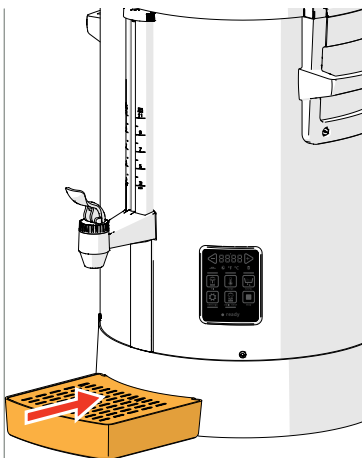

3.1b

2. place the drip tray for the B-Compact under the manual tap

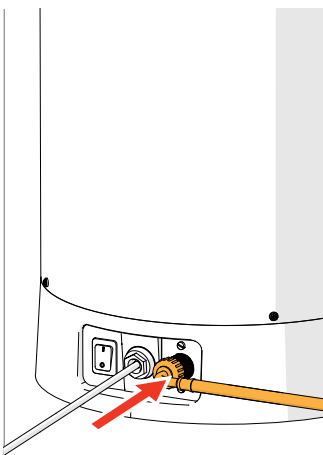

3.1c

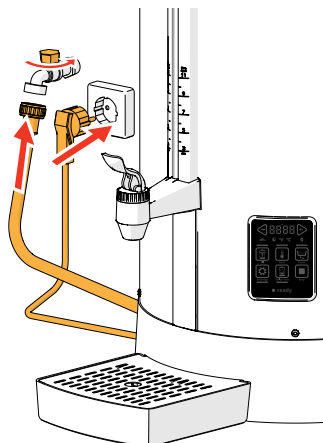

3. connect the supplied hose to the B-Compact and to a water filter or directly to the water supply

- ▶ *Only use the hose supplied.*
- ▶ *If a thinner hose is used or the water pressure fluctuates, the automatic filling process may not be optimal and the boiler may not be filled completely.*

4. open the water supply

5. insert the plug in the power socket (ensure it is earthed)

3.2 Start up

After switching on, the control display shows the set values a after the other.

If any of the 7 keys are pressed during start-up, the B-Compact goes straight to standby.

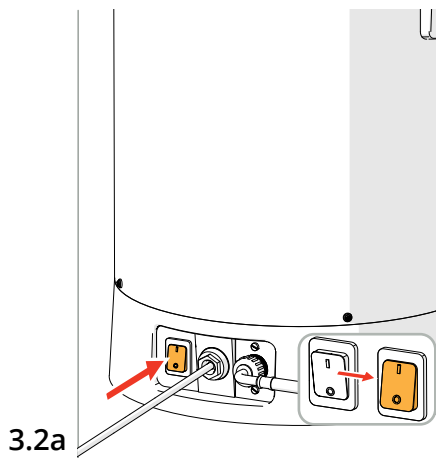

Start:

- make sure that the water supply is open
- switch the B-Compact on
- a beep sounds 
- wait for the next screen

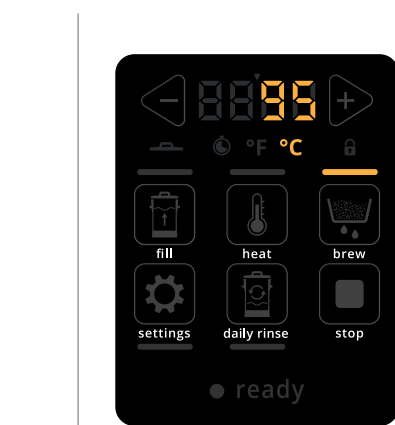

Information screen:

- last set brew temperature is displayed
- wait for the next screen

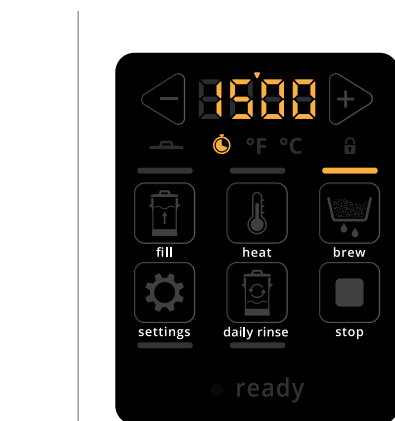

Information screen:

- last set brew time is displayed
- wait for the next screen

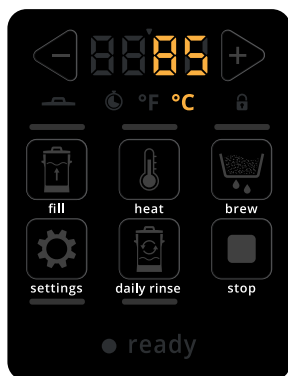

3.2d

Information screen:

- last set keep warm temperature is displayed
- wait for the standby screen, see [3.4a on p.6](#)

Standard setting:

- The B-Compact has a number of default settings (see [5.5 on p.20](#)). Check these and adjust them if necessary.

3.3 Stop button



The "stop button" will stop "automatic processes" if they are running

3.4 Standby

The device is equipped with a standby mode, this is used to save energy consumption when the B-Compact is not used.



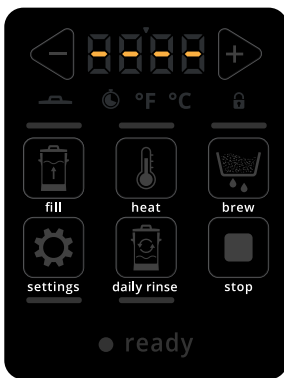

When standby becomes active, the following actions are performed:

- pump : disabled
- heating : disabled
- valve : disabled



3.4a





B-Compact is empty

- press once  to go to [§5.2 on p.15](#)
- press and hold  to go [§5.2 on p.15](#)
- press  to go [§5.3 on p.16](#)
- press  to go [§5.1 on p.13](#)
- press  to go to [§5.5 on p.20](#)



3.4b

B-Compact not empty, actual fluid temperature displayed

- press and hold the  to go to screen [5.2c on p.15](#)
- press  to go to screen [5.3c on p.16](#)
- press  to go to screen [5.1c on p.13](#)
- press  to go to [§5.5 on p.20](#)

► *If the fluid temperature is above 50 °C it is flashing.*

3.5 Prepare for use

3.5.1 Fill the coffee cone

Before a new coffee can be brewed, the cone must be fitted with new filter paper and coffee; the procedure is described below.

Necessities:

- filter cups
- quick filter coffee (regular)

<i>coffee grind size</i>	<i>recommended dosage</i>
500 µm	50 g/l
550 µm	55 g/l
650 µm	60 g/l

3.5.1a

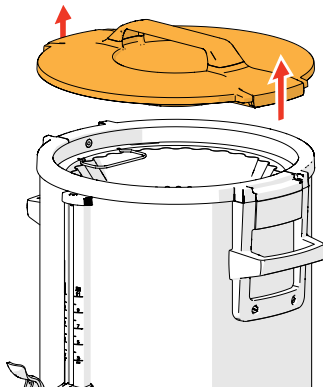

1. open and remove the lid.

3.5.1b

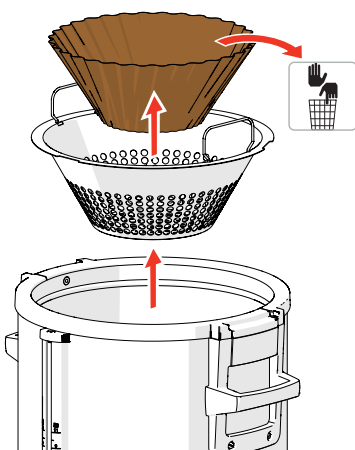

2. remove the complete filter cone
3. remove the filter with the old coffee grounds

3.5.1c

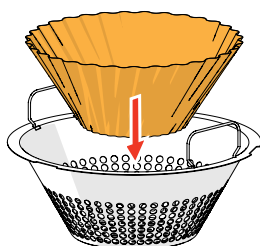

4. clean the cone if necessary (see fig. [4.1b](#))
5. place a new filter paper
▶ Exclusively use the Bravilor Bonamat® filter paper or filter paper of the same quality.
6. add the coffee grind, spread the coffee bed evenly
▶ Use the coffee grind size and with the recommended dosage.
7. place the filter cone, with coffee, in the B-Compact
8. close the lid
9. the B-Compact is now ready to brew coffee, see [§5.1 on p.13](#)

4. Cleaning

It is important that the B-Compact is kept clean, what can be cleaned:

Daily		Weekly	Periodic
drip tray	coffee kettle, daily rinse (short)	coffee kettle (thorough)	gauge glass
filter cone			
the outside			

▶ *Never clean parts of the B-Compact in the dishwasher, only if this is explicitly stated.*

▶ *Do not use any aggressive cleaning agents (e.g. natriumbicarbonaat)*

4.1 Daily cleaning

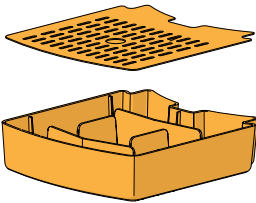

4.1a

Drip tray:

1. remove the complete drip tray
 2. empty the drip tray
 3. clean the drip tray (including grid), using *hot soapy water*
- ▶ *Dishwasher proof (< 65°C).*
4. dry everything and place them back in place

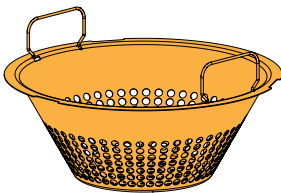

4.1b

Filter cone:

1. open the lid and remove the filter cone
 2. empty the filter cone
 3. clean the filter cone, using *hot water*
- ▶ *Dishwasher proof (< 65°C).*
4. dry everything and place them back in place

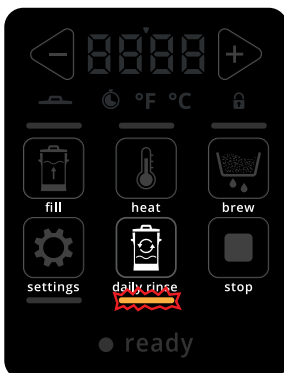

4.1.ca

Coffee kettle (short rinse without cleaner):

1. empty the B-compact completely by using the manual tap
 2. place the lid and switch on the B-Compact
- ▶ *The lid must be in place; otherwise, a message will appear (see screen [5.4d](#) on p.19).*
3. press the "daily rinse" button once (briefly)
 - » the "daily rinse" indicator light is flashing and the "fill" animation is displayed



- the next screen will appear automatically

▶ *If the appliance is not connected to the water supply, fill it with 4 litres of clean water.*

4.1.cb

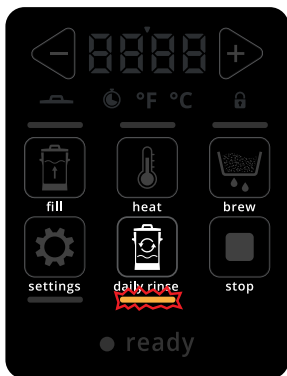

» the "daily rinse" indicator light is still flashing and the "circulate" animation is displayed

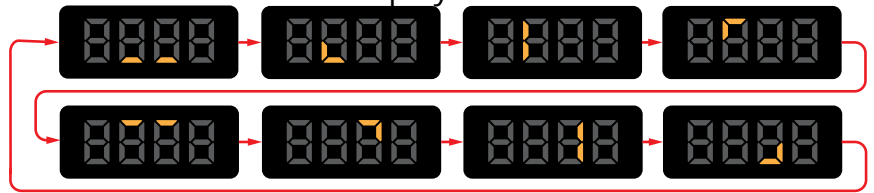

- two beeps sounds 🗣️ 🗣️ will indicate that the rinsing is ready
 - the next screen will appear automatically
- The lid must be in place; otherwise, a message will appear (see screen [6.1a on p.23](#)).

4.1.cc

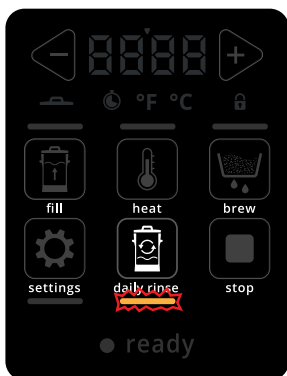

» the "daily rinse" indicator light is still flashing and the "empty" animation is displayed



4. empty the B-compact completely by using the manual tap
- » the "empty" animation will disappear after 30 seconds

4.1.cd

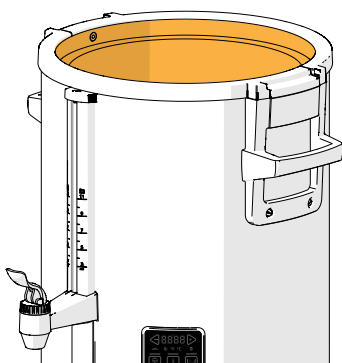

5. switch off the B-Compact
 6. remove the lid and the filter cone
- Be aware that both the lid and the condensation water from the lid can be hot to the touch!
7. use a damp cloth to remove any remaining debris
 8. replace all parts
- the B-Compact is ready to use again
- After use, always replace the lid on the machine.

4.1.d

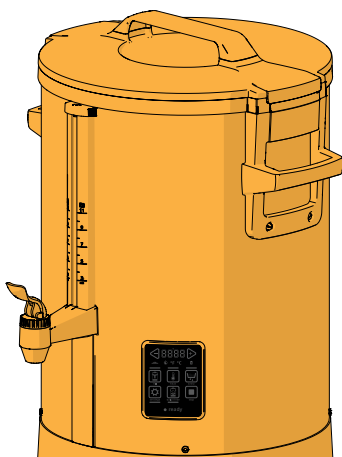

Outside:

1. switch off the B-Compact
2. clean the outside, using a damp cloth

4.2 Weekly cleaning

Over time, coffee deposits can form into the kettle and on the filter cone.

To get rid of these coffee residues, the following procedure should be repeated either weekly *or after max. 20 coffee brews*.

- ▶ Use only a non aggressive product due to save the gaskets.
We recommend the Bravilor Cleaner.
- ▶ Dissolve four sachets (4 x 15 g) of Bravilor cleaner in one litre of water (approximately 60°C).
Stir until the cleaner has completely dissolved.

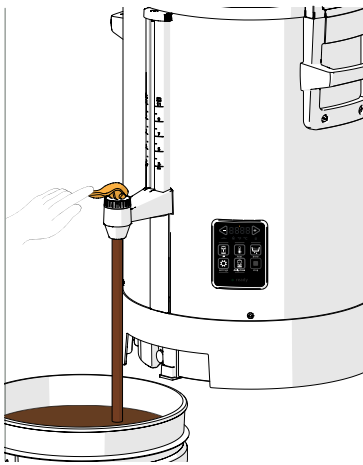

4.2a

Coffee kettle (thorough rinse with cleaner):

1. place a bucket under manual tap
2. empty the B-Compact completely using the manual tap
3. open the lid and remove the filter cone, see fig. [3.5.1a](#)
4. pour the solution into the B-Compact.

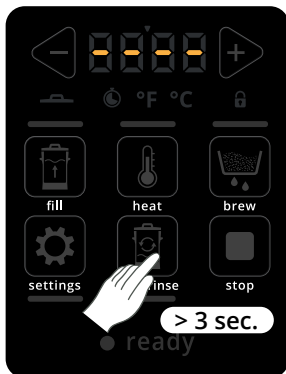

4.2b

5. press and hold the "daily rinse" button for **at least 3 seconds**
» the "daily rinse" indicator light is flashing and the "fill" animation is displayed

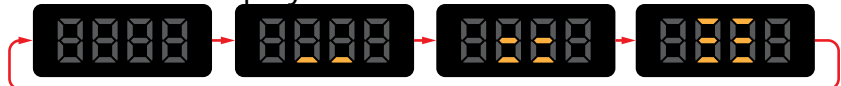

- the next screen will appear automatically
 - ▶ If the B-Compact is not connected to the water supply, fill it with 10 litres of clean water.
 - ▶ The lid must be in place; otherwise, a message will appear (see screen [5.4d on p.19](#)).

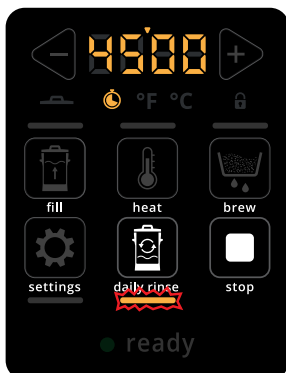

4.2c

- » the rinsing procedure time counts down from 45 minutes
- three beeps sounds (🔊 🔊 🔊) will indicate that the rinsing is ready
- the next screen will appear automatically
 - ▶ The lid must be in place; otherwise, a message will appear (see screen [6.1a on p.23](#)).

4.2d

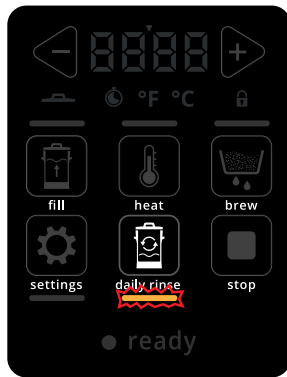

» the "daily rinse" indicator light is still flashing and the "empty" animation is displayed



6. dispense approximately 5 litres using the manual tap, then close it
7. use the drain hose behind the drip tray to drain the next 5 litres (see fig. 4.2e)
8. close the drain hose with its cap
9. open the manual tap once more to remove any residual water
 - » The "empty" animation will disappear after 30 seconds.

► *Be aware that both the lid and the condensation water from the lid can be hot to the touch!*

10. dry the inside, and loose parts, with a damp(!), clean cloth
11. take the cylindrical sieve out of the kettle and clean it by hand
12. replace all parts
13. finally start the daily rinse procedure (see steps [4.1.ca on p.8](#) to [4.1.cc on p.9](#))

4.2e

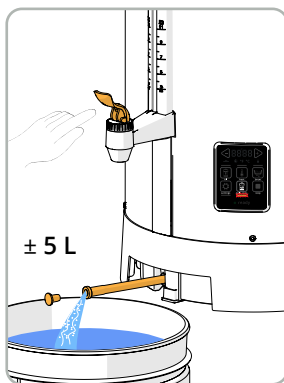

► *In the event that the "weekly cleaning procedure" is unsuccessful in removing the stubborn dirt, the filter basket and cylindric filter can be cleaned separately.*

- » Prepare a solution comprising five litres of water and two cleaning sachets.
- » Please ensure that the parts are left immersed in a bucket for approximately 30 minutes
- » Clean all parts thoroughly using a suitable brush.
- » Rinse the items thoroughly and then allow them to dry.
- » Please ensure that all parts are correctly replaced.

► *After use, always replace the lid on the machine.*

4.3 Periodic cleaning

4.3.1 Clean the gauge glass

Over time, coffee deposits can form in the gauge glass.

It may therefore be necessary to clean the gauge glass separately with a gauge glass brush. This can be ordered from Bravilor Bonamat under number 7.110.605.101.

4.3.1a

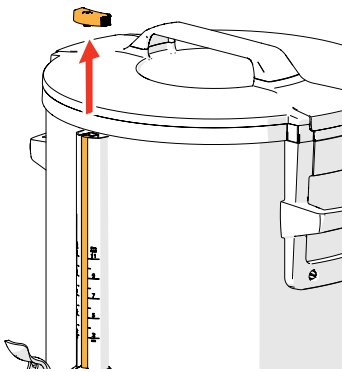

► *Handle the gauge glass with care, it is very fragile.*

1. switch off the B-Compact
2. drain through the manual tap
3. remove the gauge glass cover by gently tilting it forward slightly and pulling it upwards

4.3.1b

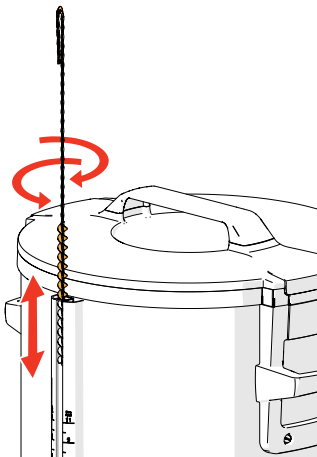

4. clean the gauge glass

► *Use a special gauge glass brush.*

5. carefully replace the cover onto the sight glass

► *Be sure the 2 O-rings are in place.*

6. perform the weekly cleaning, see [§4.2](#)

► *After use, always replace the lid on the machine.*

5. Functions of the buttons

5.1 Automatic brewing

The fully automatic brewing process is described in this section.

The following sections describe the manual startable parts.

- to cancel the process, press  and go to the standby mode [3.4 on p.6](#)

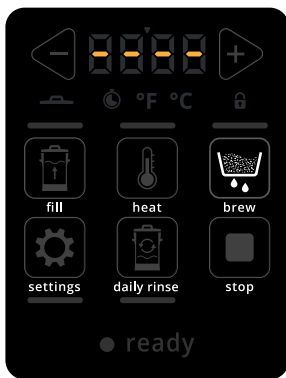

5.1a

Standby mode, when B-Compact is empty:

- press the "brew button" 

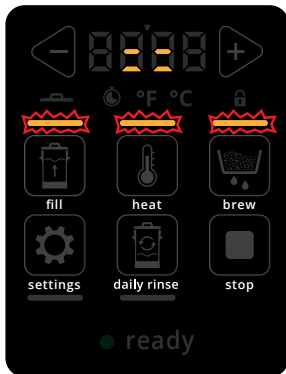

5.1b

Information screen filling and heating:

- ▶ The fill animation (see [§5.2 on p.15](#)) alternating with the current water temperature.
- ▶ The "fill", "heat" and "brew" indicator lights are flashing. When the B-Compact is filled the next screen appears



5.1c

Information screen, heating:

- ▶ The "heat" and "brew" indicator lights are flashing.
- ▶ The temperature continues to rise until the set brew temperature is reached, then the following screen appears.
- ▶ The lid must be in place; otherwise, a message will appear (see screen [6.1a on p.23](#)).

Information screen coffee brewing process:

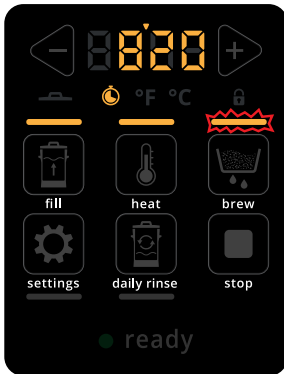

5.1d

- ▶ *The lid must be in place; otherwise, a message will appear (see screen [6.1a on p.23](#)).*
- ▶ *The "brew" indicator light is flashing at normal speed and the coffee brewing time is decreasing.*
- ▶ *The coffee brewing time runs down to 0 and the the next screen will appear*
- when the coffee brewing process is ready, the B-compact beeps three times 🗣️🗣️🗣️
- after a few seconds the next screen will appear



5.1e

Coffee ready:

- the temperature, the ready indicator are displayed and a *beep sounds* 🗣️
- ▶ *The lid must be in place; otherwise, a message will appear (see screen [6.1a on p.23](#)).*

▶ *After use, always replace the lid on the machine.*

5.2 Only filling the machine

Objective: to prepare the machine.

There are three ways to fill the B-Compact:

- Automatic
- Semi automatic
- Hand fill (machine zonder vaste wateraansluiting)
 - ▶ *The B-Compact must always be filled with cold water from the mains.*

• to cancel the process, press to go to screen [3.4b on p.6](#)

During Automatic and semi-automatic filling, the display shows the following as an animation.



5.2a

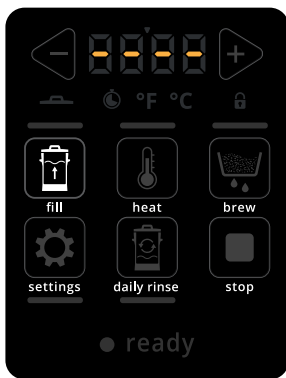

Standby mode, when B-Compact is empty:

Automatic filling:

- press once to go to the next screen
 - ▶ *Once this procedure is completed, the remaining buttons are available.*
 - ▶ *The amount depends on setting S 05 (see [§5.5 on p.20](#))*

Semi-automatic filling:

- press and hold to go to screen [5.2c](#)
 - ▶ *When this procedure is completed, the B-Compact switches to a standby mode.*

5.2b

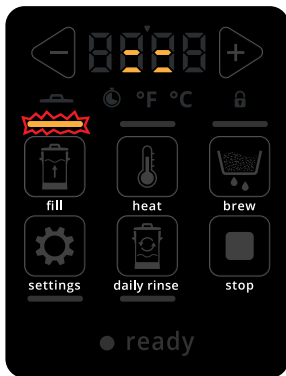

Automatic filling:

- ▶ *The "Fill" indicator is flashing and the fill animation is displayed.*
- a *beep sounds* when the B-Compact is filled entirely then go to the next screen

5.2c

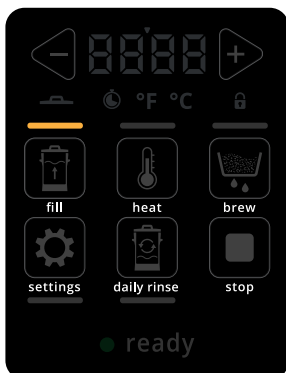

B-Compact is filled entirely.

- ▶ *Depending on irregularities in the water supply at the location, the automatic filling procedure may result in an incompletely filled B-compact. In this case, fill the rest of the B-compact to the required amount using the semi-automatic filling procedure.*
- press to go to screen [5.3c on p.16](#)
- press to go to screen [5.1c on p.13](#)
- press to go to settings navigation, see [§5.5 on p.20](#)

5.3 Fill and (pre-)heat

Objective: to get the machine ready and up to temperature so that you can quickly make coffee when you need it and don't have to wait for it to heat up.

During Automatic filling, the display shows the following as an animation.



The B-Compact will automatically start heating once it has been filled.

- to cancel the process, press  to go to screen [3.4b on p.6](#)

Standby mode, when B-Compact is empty:

- press the "heat button" 

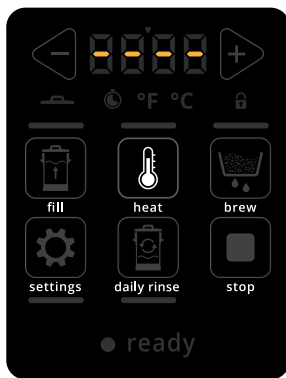

5.3a

Information screen filling and heating:

- ▶ The fill animation (see [5.2 on p.15](#)) alternating with the current water temperature.
- ▶ The "fill" and "heat" indicator lights are flashing.
- ▶ When the B-Compact is filled the next screen appears
- press  to go to screen [5.1b on p.13](#)

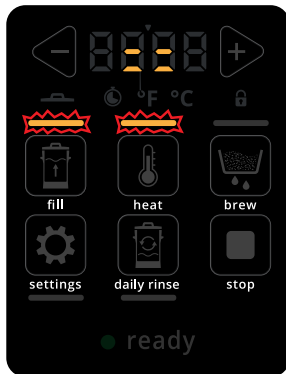

5.3b

Information screen, heating:

- ▶ The "heat" indicator light is flashing.
- ▶ The lid must be in place; otherwise, a message will appear (see screen [6.1a on p.23](#)).



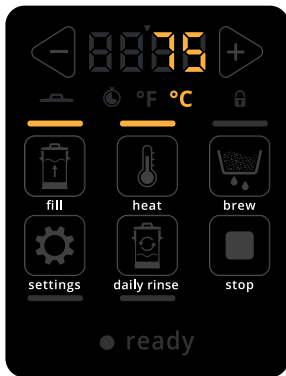

5.3c

The B-Compact has finished heating



5.3d

► Depending on irregularities in the water supply at the location, the automatic filling procedure may result in an incompletely filled B-compact. In this case, fill the rest of the B-compact to the required amount using the semi-automatic filling procedure.

- a beep sounds  when the B-Compact set temperature has reached
- press  to go to screen [5.1c on p.13](#)

Top up:

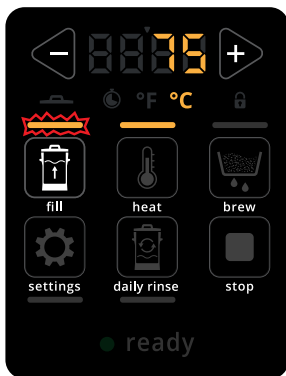

5.3e

- press and hold  to top up the B-compact

► The "fill" indicator light is flashing.

- when the button  is released the B-compact stops filling
- press  to go to screen [5.1c on p.13](#)

► After use, always replace the lid on the machine.

5.4 Daily rinse

There are two ways to use the daily rinse button.

1. Press once briefly at the end of the day to rinse the machine daily and prevent the float from sticking (the float is in the coffee liquid). Its use can be seen below.
2. Press and hold (for at least 3 seconds) to rinse the machine with a cleaning agent on a weekly basis (used in [§4.2 on p.10](#)).

Rinse procedures	Time (total)	water quantity	Cleaning agent
press (briefly)	±5 min	±4 litre	no
press and hold (3 sec.)	±50 min	±10 litres (default), depends on the set filling time (§5.5 on p.20)	yes

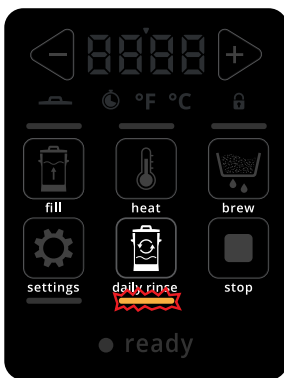

5.4a

- activate the "daily rinse button" function by pressing it briefly.
» the "daily rinse" indicator light is flashing and the "fill" animation is displayed

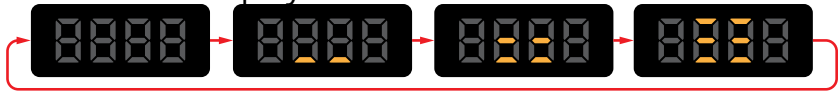

- the next screen will appear automatically

► The lid must be in place; otherwise, a message will appear (see screen [5.4d on p.19](#)).

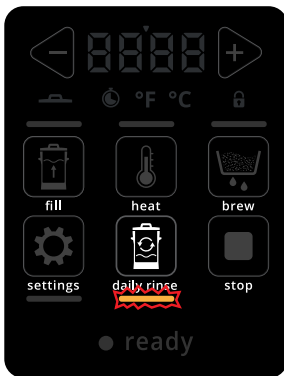

5.4b

- » the "daily rinse" indicator light is still flashing and the "circulate" animation is displayed

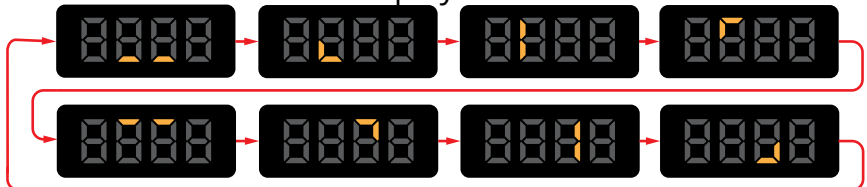

- two beep sounds (🔊🔊) will indicate that the rinsing is ready
- the next screen will appear automatically

► The lid must be in place; otherwise, a message will appear (see screen [6.1a on p.23](#)).

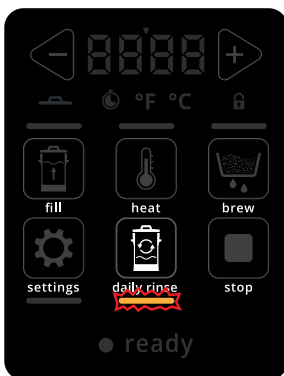

5.4c

- » the "daily rinse" indicator light is still flashing and the "empty" animation is displayed

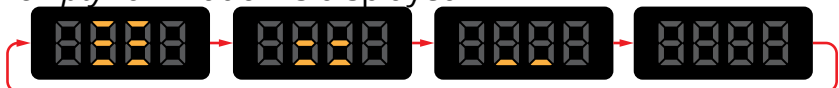

- drain the B-Compact as in [4.2b on p.10](#)
- the "empty" animation will disappear after 30 seconds
- the B-Compact is ready to use again

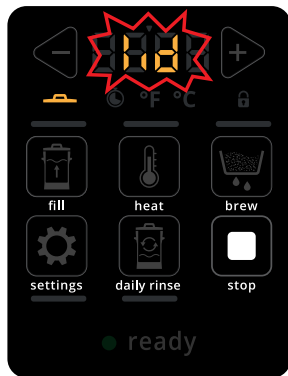

5.4d

- ▶ *If the lid is not in place, the word 'LID' will flash and the lid icon will illuminate.*
- ▶ *Circulation will pause until the lid is replaced, after which the process will continue.*
- ▶ *A beep  also sounds if the temperature is 50°C or higher.*

▶ *After use, always replace the lid on the machine.*

5.5 Setting items

The setting button is available if no other processes are running

Setting	Standard	adjust from - to	
S 01	brew temperature	95°C (203°F)	85 - 95°C (185 - 203°F)
S 02	brew time	15 minutes	4 - 20 minutes
S 03	heat temperature	85°C (185°F)	75 - 90°C (167 - 194°F)
S 04	pump time	50%	10 - 100%
S 05	fill time	50 seconds	25 - 72 seconds
S 06	temperature notation	°C	°C / °F
S 07	sound volume	2	0 (off) - 3 (max.)
-	pre-heat temperature	75°C (167°F)	not adjustable

Setting mode:



5.5a

- ▶ The setting button is available if no other processes are running
- press the ◀ or ▶ to scroll through the different setting items (carousel see screen 5.5b to 5.5g)
- press the "setting button" ⚙️ to select the displayed setting

Brew temperature (S 01):



5.5b

- ▶ The temperature at which the coffee is made.
- press the ◀ or ▶ to change the value
- press ⚙️ to save the changes
- when ready a *beep sounds* 🔊 and the carousel is displayed
- to cancel press ◻️ and go back to the carousel

Brew time (S 02):



5.5c

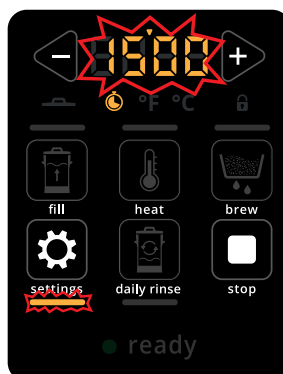

- ▶ The time at which the coffee is made.
- press the ◀ or ▶ to change the value
- press ⚙️ to save the changes
- when ready a *beep sounds* 🔊 and the carousel is displayed
- to cancel press ◻️ and go back to the carousel

5.5d

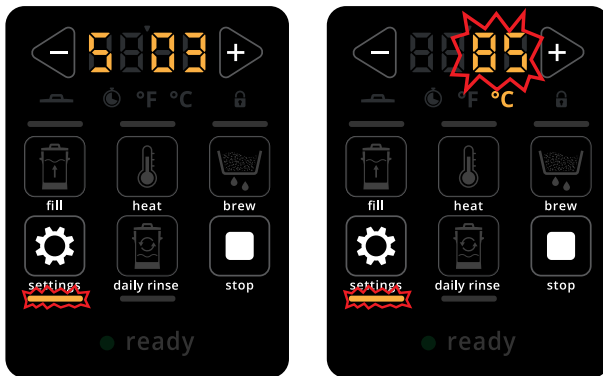

Keep warm temperature (**S 03**):

► *The temperature at which coffee is kept warm after brewing.*

- press the ◀ or ▶ to change the value
- press ⚙ to save the changes
- when ready a *beep* sounds 🔊 and the carousel is displayed
- to cancel press □ and go back to the carousel

5.5e

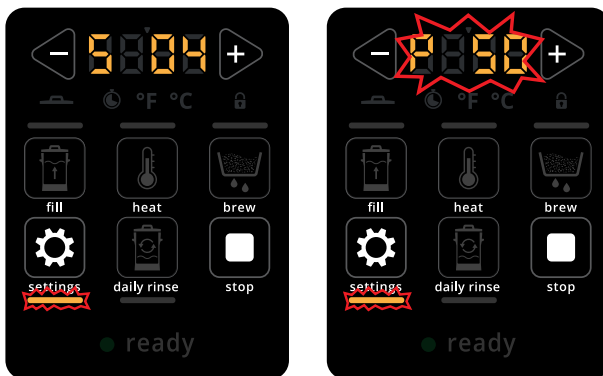

Pump time (**S 04**):

► *To dose the amount of water in the filter pan, the pump should occasionally switch off. This is to prevent overflow when using a lot of and/or fine coffee. Or if soft water is used, as it has the property of sinking badly through the coffee filter.*

- press the ◀ or ▶ to change the value
- press ⚙ to save the changes
- when ready a *beep* sounds 🔊 and the carousel is displayed
- to cancel press □ and go back to the carousel

5.5f

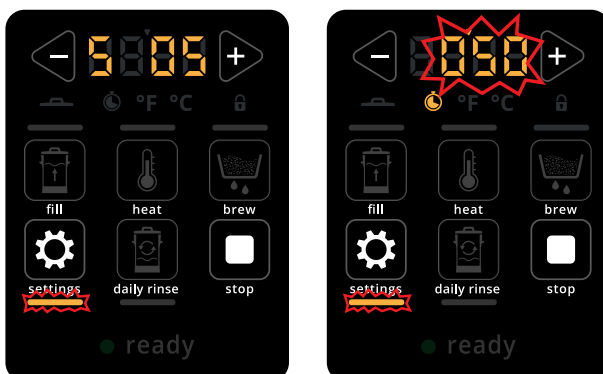

Fill time (**S 05**):

► *The time it takes to fill the machine with water. This determines the amount of water in the kettle.*

- press the ◀ or ▶ to change the value
- press ⚙ to save the changes
- when ready a *beep* sounds 🔊 and the carousel is displayed
- to cancel press □ and go back to the carousel

5.5g

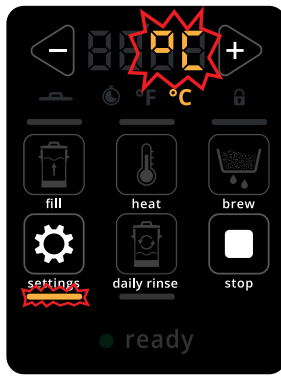
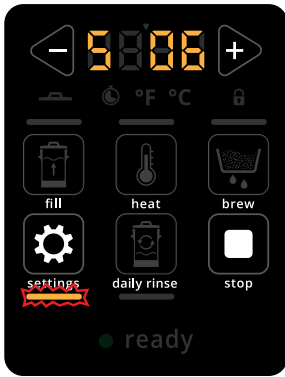

Temperature notation (**S 06**):

- press the ◀ or ▶ to change the value
- press ⚙ to save the changes
- when ready a *beep sounds* 🔊 and the carousel is displayed
- to cancel press □ and go back to the carousel

5.5h

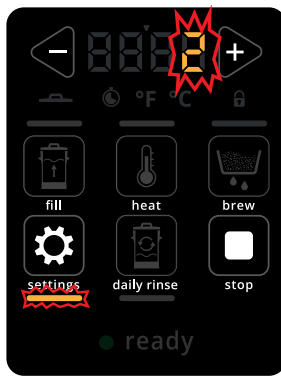
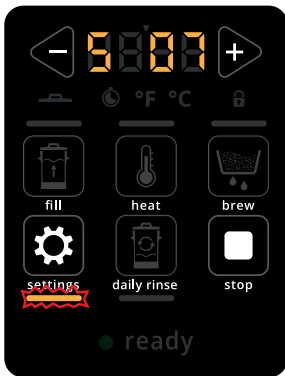

Sound Volume (**S 07**):

- press the ◀ or ▶ to change the value
- press ⚙ to save the changes
- when ready a *beep sounds* 🔊 and the carousel is displayed
- to cancel press □ and go back to the carousel

6. Special functions

6.1 Lid warning

The lid can be removed from the B-Compact without consequences when the fluid temperature is below 50°C (120°F), since this is a safe temperature for people.

If different, the current process running is interrupted when the lid is removed.



If a process is started while the fluid temperature is between 0-50°C (32-122°F), the lid indicator will flash as a reminder that the lid must be in place.

As soon as the fluid reaches 50°C (122°F) the text "lid" appears and the B-Compact stops heating, the temperature is kept at 50°C (122°F), as soon as the lid is placed the procedure started can continue.

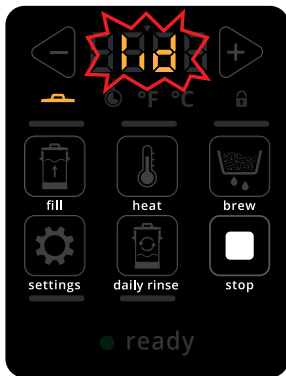
Lid warning:





6.1a

- ▶ *The lid is not present while the temperature is higher than 50°C (120°F).*
- a beep sounds , the lid indicator lights up and "lid" is flashing in the display
- reposition the lid
- ▶ *The B-compact resumes the process that was interrupted by removing the lid.*
- press  to cancel the interrupted process

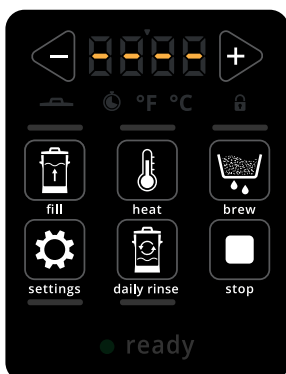
6.2 Back to default settings



6.2a

- press and hold  and  for 10 seconds.
- ▶ *the display flashes for 3 seconds (0.5 seconds on and off)*

- ▶ *The machine will then go back to the factory settings (the settings it came with).*

6.3 Lock mode (Buffet setting)



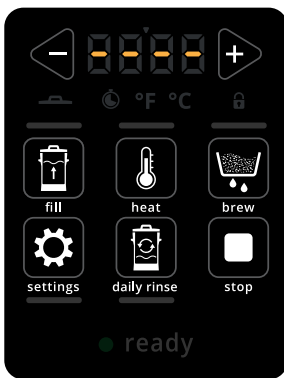

The machine can be locked when the machine is:

- in standby
- filling
- heating
- brewing
- circulating



6.3a

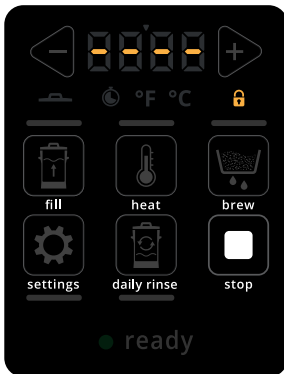

Lock the B-Compact:

- press  and  together for 2 sec.
- a *beep sounds*  go to the next screen
- press  to cancel the interrupted process



6.3b



Locked B-Compact:

- ▶ *The lock indicator illuminates and all buttons are inactive except the "stop" button *
- ▶ *If a button other than "stop" is pressed, the lock indicator flashes once.*
- press  to unlock the B-Compact

7. Errors

Error messages appear when an error is detected by the B-Compacts operating system. The error can be accompanied by an acoustic signal (1 sec on - 2 sec off - 1 sec on etc.)

► *If the error message returned after the appropriate action, please contact your dealer.*

code	description	action
E 02	<p>temperature sensor out of range <i>This appears when the temperature reading is outside normal range.</i></p>	<p>» if the error persists, contact your dealer</p>
E 06+ 	<p>water supply failure <i>This appears when the filling time has elapsed (inlet valve open) and the float is not in the upper position after 40 seconds.</i></p>	<ul style="list-style-type: none"> • check that the water tap is open • check that the water supply hose is not kinked • check whether fluid comes out of the beverage tap • make sure the float can move <p>» if the error persists, contact your dealer</p>
E 13+ 	<p>button sticking <i>This appears when when the buttons below are pressed for longer than:</i></p> <ul style="list-style-type: none"> • flush button longer than 160 seconds pressed • fill button longer than 90 seconds pressed • other buttons longer than 30 seconds pressed 	<ul style="list-style-type: none"> • release the button to reset the error <p>» if the error persists, contact your dealer</p>
E 14	<p>machine doesn't heats up when the heating element should be switched on <i>This appears when no temp rise in 30 minutes, with heating elements both on.</i></p> <p>► <i>This doesn't apply when the 'keep warm' function is activated.</i></p>	<p>» if the error persists, contact your dealer</p>
E 15+ 	<p>machine heats up when the heating element shouldn't be switched on <i>This appears when the temperature sensor detects the machine boils for 10 minutes.</i></p>	<p>» if the error persists, contact your dealer</p>

8. Storing the B-Compact

The following points should be noted if the B-Compact is to be stored for a longer period of time.

1. Clean the B-Compact by following *all the steps* described in [§4](#).
2. Allow everything to dry thoroughly after cleaning. This will prevent mould growth.
3. Disconnect the plug from the socket.
4. Turn off the water tap.
5. Disconnect the hose from the water connection and the B-Compact (in the case of a fixed water connection).
6. Store the water hose in the machine.
7. ***The lid on the B-Compact must be replaced every time it is stored away.***
8. Store the B-Compact in a dry, frost-free location.

Brewing your coffee

S I N C E 1 9 4 8